

## 符号/Symbol

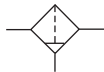

## 规格/Specification

保证耐压力/ Ensured Pressure Resistance	1. 5MPa(15kgf/cm <sup>2</sup> )
最高使用压力/Highest Working Pressure	1.0MPa(10kgf/cm <sup>2</sup> )
环境及流体温度/ Ambient and Fluid Temperature	5~60°C
*过滤精度/ Filter Precision	25µm
**滤芯材质/**Filter material	铜/Brass
容器材料 Container Material	聚碳酸酯 /Polycarbonate
防护罩 /Protective Cover	AF2000(无/No) AF3000-5000(有/Available)

\*还有5. 50µm可供选择。/\*5.50µm are available

\*\*还有PE材料滤芯可供选择/\*\*PE material filter element is available.

型号 /Model	规格/ Specifications			配件 / Accessories	放水器功能/ Drain Function	注1) 自动排水型号/ AutoDrainModel
	注2)额定流量 /Note 2) RatedFlow(L/min)	注3)接管口径 /Note 3) Port Size(G)	杯容量(cm <sup>3</sup> ) /Bowl Capacity	托架 /Bracket		
AF2000-02	750	1/4	15	B240	a.停气排水 /Air Shutoff Drain	AF20 00-02D
AF3000-02	1500	1/4	20	B340		AF3000-02D
AF3000-03	1500	3/8	20	B340		AF3000-03D
AF4000-04	4000	1/2	45	B440		AF4000-04D
AF4000-06	6000	3/4	45	B540		AF4000-06D
AF5000-06	7000	3/4	130	B640		AF5000-06D
AF5000-10	7000	1	130	B640	b.手动排水 /Manual Drain	AF5000-10D

注1) AF2000有两种自动排水结构可选，脉冲式自动排水器为常规选型，还有杠杆式自动排水器可选，订货时用“D2”表示；如：AF2000-02D2；AF3000~AF5000自动排水器结构以杠杆式为常规选型，还有浮球式自动排水器可选，详细说明请参阅自动排水器介绍。

注2) 供应压力为0.7MPa(7.1kgf/cm<sup>2</sup>)的情况下。

注3) 接管口径另有Rc、NPT螺纹可供选择。

Note 1) There are 2 types auto drain for AF2000, pulsed type and lever type."D" means normal auto drain, pulsed type:"D2" means lever type auto drain. For Example: AF2000-02D2.

The normal auto drain for AF3000-AF5000 is lever type, but the float type auto drain is available for choose. Please check the details from AUTO DRAIN in page 70.

Note 2) The inlet pressure is 0.7MPa(7.1 kgf/cm<sup>2</sup>)

Note 3) Rc ,NPT thread are available.

## 主零件/ Main Parts

序号/No.	名称/ Denomination	材料/ Material
1	阀体 /Valve Body	铝压铸件/ Aluminum Die Casting
2	滤芯/ Filter Element	铜/ Brass
3	淌水板 /Drain Board	ABS
4	O形圈/O-ring	橡胶/ Rubber
5	存水杯(防护罩)/ Water Storage Cup( Protective cover)	聚碳酸酯(冷轧板) /Polycarbonate(Cold Rolled sheet)
6	旋风叶片/ Whirlwind Blade	ABS
7	O形圈/O-ring	橡胶/ Rubber
8	中间体/ Middle Part	铝压铸件/ Aluminum Die Casting

## 外形尺寸图/Overall Dimension Drawing(mm)

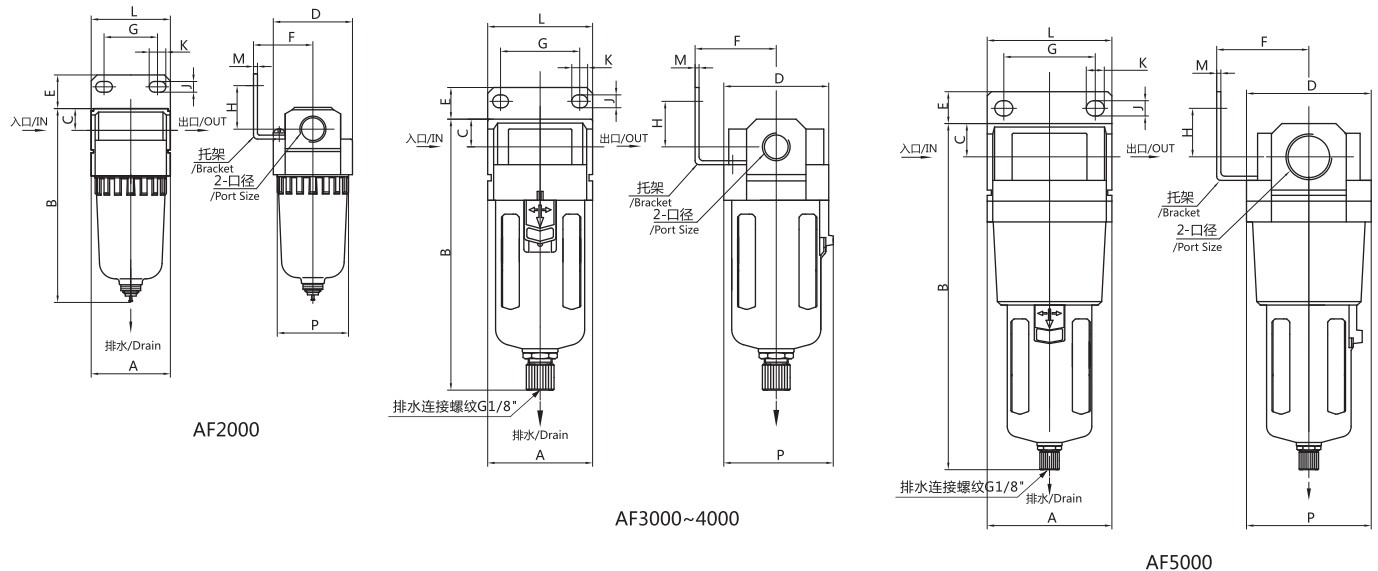

## 尺寸表/Dimension Sheet (mm)

型号/Model	口径/Port Size(G)	A	B	C	D	E	F	G	H	J	K	L	M	P	B(带自动排水器)/B(With Auto drain)	B(带自动排水器)/B(With Auto drain)
AF2000-02	1/4	40	97.5	11	40	17	30	27	22	5.4	8.4	40	2.3	40	119	*134
AF3000-02	1/4	53	132.5	14	53	16	41	40	23	6.5	8	53	2.3	56		148
AF3000-03	3/8	53	132.5	14	53	16	41	40	23	6.5	8	53	2.3	56		148
AF4000-04	1/2	70	168.5	18	70	17	50	54	26	8.5	10.5	70	2.3	73		173
AF4000-06	3/4	75	172.5	20	70	14	50	54	25	8.5	10.5	70	2.3	73		177
AF5000-06	3/4	90	247.5	24	90	23	66.5	66	35	11	13	90	3.2	90		252
AF5000-10	1	90	247.5	24	90	23	66.5	66	35	11	13	90	3.2	90		252

\*标注标尺寸为杠杆式自动放水器高度尺寸。

\* This size is for lever type auto drain.

## 流量特性曲线/ Characteristic Curve of Flow Rate

AF2000 1/8-1/4

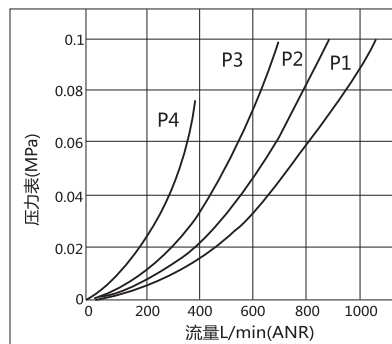

AF3000 1/4-3/8

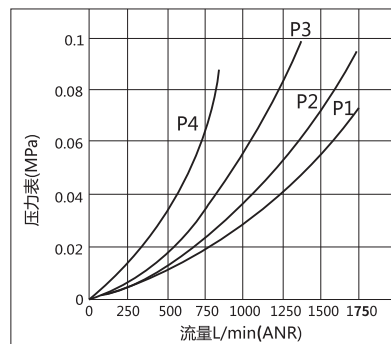

AF4000 3/8-1/2

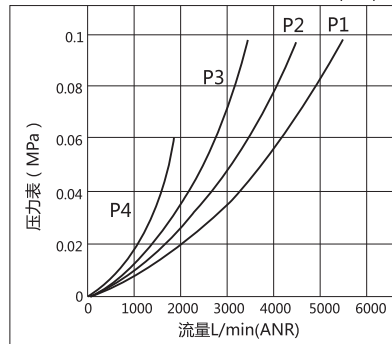

AF4000-06 3/4

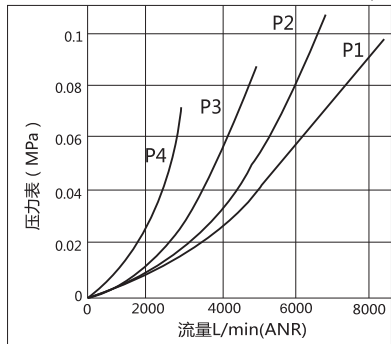

AF5000 3/4-1

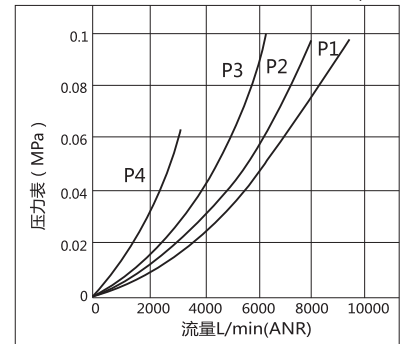

注：P1=0.7MPa P2=0.5MPa P3=0.3MPa P4=0.1MPa